

▶ 代理KODEN
KODEN PRODUCTS

船用雷达MDC2200/2500 系列
Marine Radar MDC2200/2500 Series



12/15英寸 彩色LCD船用雷达/12-inch/15-inch Color LCD

产品分级的高端雷达系列

High-end Radar series forming a class apart

产品选型
PRODUCT CATALOGUE



规格/Specifications

天线扫描单元Antenna-scanner unit

| | | | | | | | | |
|----------------------------------|--|-------------------------|--------------------------------|-------------------------|--------|---------------------------------|--------|--------|
| 型号Model | MDC-2240 MDC-2540/BB | MDC-2260 MDC-2560/BB | MDC-2210 MDC-2510/BB | MDC-2220 MDC-2520/BB | | | | |
| 类型 Type | RB716A | RB717A | RB718A | RB719A | | | | |
| 天线类型Antenna type | Open antenna | | | | | | | |
| 天线长度 Antenna length | 3 feet | 4 feet | 4 feet | 6 feet | 4 feet | 6 feet | 6 feet | 9 feet |
| 输出功率(峰值)Output power (peak) | 4 kW | | 6 kW | | 12 kW | | 25 kW | |
| 输出频率Output frequency | 9410 MHz to 30 MHz | | | | | | | |
| 水平波束宽度Horizontal beam width | 2.5° | 1.8° | 1.8° | 1.2° | 1.8° | 1.2° | 1.8° | 0.8° |
| 垂直波束宽度Vertical beam width | 22° | | | | | | | 25° |
| 转速Rotation | 24 rpm or 48 rpm | | | | | | | |
| 中频中心频率IF center frequency | 60 MHz | | | | | | | |
| 量程准确度 Range accuracy | 8 meters or 1% of the range scale selected, whichever is the greater | | | | | | | |
| 航向准确度Bearing accuracy | 1° or less | | | | | | | |
| 最小监测距离Minimum detecting distance | Within 25 m | | | | | | | |
| 量程分辨率Range resolution | Within 25 m | | | | | | | |
| 脉冲宽度Pulse width | 0.08 us, 0.25 us, 0.8 us | | 0.08 us, 0.25 us, 0.5 us, 1 us | | | 0.08 us, 0.3 us, 0.6 us, 1.2 us | | |
| 环境Environmental | | | | | | | | |
| 操作温度Operating temperature | -25°C to +55°C | | | | | | | |
| 水防护Water protection | IPX6 | | | | | | | |

显示单元Display unit

| | | |
|--|--|--|
| 型号Model | MDC-2240/2260/2210/2220 | MDC-2540/2560/2510/2520 MDC-2540BB/2560BB/2510BB/2520BB |
| 显示单元Display unit | MRD-101 | MRD-102 (Deselect BB type) |
| 显示尺寸与类型Display size and type | 12.1" color TFT LCD | 15" color TFT LCD (Deselect BB type) |
| 处理单元 仅BB类型 Processor unit (BB type only) | - | MRM-102 |
| 有效直径Effective diameter | 184 mm | 228 mm |
| 显示分辨率Display resolution | 1024 x 768 pixels (XGA) | |
| 离心Off-centering | Max. 66% | |
| 回波区域Echo area | 2 types (Full screen, Inside of effective diameter) (2种, 全屏或有效直径内) | |

| | | | | |
|--|--|---|---|---|
| 型号Model | MDC-2240, 2540/BB | MDC-2260, 2560/BB | MDC-2210, 2510/BB | MDC-2220, 2520/BB |
| 基本量程Basic range | 0.125 to 48 NM | 0.125 to 72 NM | | 0.125 to 96 NM |
| 量程刻度Range scales | 0.125 0.25 0.5 0.75 1 1.5 2 3 4 6 8 12 16 24 32 48 64 72 96 | | | |
| 量程间距 Range interval | 0.0625 0.125 0.25 0.5 0.75 1 1.5 2 3 4 6 8 12 16 18 24 | | | |
| 显示模式Presentation modes | 船首向上 Head-up, 北向上 North-up*, 航迹向上 Course-up* | | | |
| 指示系统Indication system | PPI | | | |
| 视频水平Video level | 8 levels (colors) | | | |
| 量程单元Range unit | NM, km,sm | | | |
| 报警Alarm | Echo (IN / OUT), ATA / AIS (CPA / TCPA), Guard zone etc. | | | |
| 功能Functions | Interference rejection, Target expansion, Zoom, 2 VRM, 2 EBL (true*/ relative), Floating EBL / VRM, Cursor position (Lat / Lon**), Parallel cursor, Day / Night mode, Bearing (true*/ relative), Trail**, Past course**, Mark**, Route**, RGB Monitor output, Slave display monitor input / output, External Buzzer output | | | |
| 输入数据文本与句式 Input data format and sentences | NMEA 0183 Ver.1.5/2.0/3.0 BWC, DBT, DPT, DTM, GGA, GLC, GLL, GNS, HDG, HDM, HDT, MTW, RMA, RMB, RMC, RTE, VBW, VDR, VHW, VTG, WPL, ZDA | | | |
| 输出数据文本与句式 Output data format and sentences | NMEA 0183 Ver.2.0 HDT, VHW, VTG, GLL, VDR, RSD, OSD, TTM, TLL | | | |
| 触点 NMEA port(s) | 3 (input 1, input / output 2) | | | |
| AIS接口AIS interface | 200 targets | | | |
| ATA** | 50 targets | | | |
| 电源Power supply | 10.8 to 41.6 VDC | | | |
| 电源消耗Power consumption(at 24 VDC) | MDC-2240: 80 W or less MDC-2540: 100 W or less MDC-2540BB: 80 W or less | MDC-2260: 110 W or less MDC-2560: 130 W or less MDC-2560BB: 110 W or less | MDC-2210: 130 W or less MDC-2510: 150 W or less MDC-2510BB: 130 W or less | MDC-2220: 170 W or less MDC-2520: 200 W or less MDC-2520BB: 180 W or less |

环境Environmental

| | |
|----------------------------|--|
| 操作温度 Operating temperature | -15°C to +55°C |
| 水防护 Water protection | IPX 5 (BB type with optional water protection RGB cable) |

设备清单/ Equipment list

标配 Standard equipment

| | | | |
|--------------------------------------|-----------------|--------|---|
| 天线扫描单元 Antenna-scanner unit | RB716A | 4 kW | MDC-2240, 2540 / BB |
| 扫描单元 Scanner unit | RB717A | 6 kW | MDC-2260, 2560 / BB |
| | RB718A | 12 kW | MDC-2210, 2510 / BB |
| | RB719A | 25 kW | MDC-2220, 2520 / BB |
| | RW701A-03 | 3 feet | MDC-2240, 2540 / BB |
| 天线单元 Antenna unit | RW701A-04 | 4 feet | MDC-2240, 2260, 2210, 2540 / BB, 2560 / BB, 2510 / BB |
| | RW701A-06 | 6 feet | MDC-2260, 2210, 2520, 2560 / BB, 2510 / BB, 2520 / BB |
| | RW701B-09 | 9 feet | MDC-2220, 2520 / BB |
| 显示单元 Display unit (deselect BB type) | MRD-101 | | MDC-2200 series |
| | MRD-102 | | MDC-2500 series |
| 操作单元 Operation unit | MRO-102 | | MDC-2500 / BB series |
| 处理单元 Processor unit | MRM-102 | | MDC-2500BB series |
| 连接电缆 Connecting cable | 242J159098B-15M | | 15 m |
| DC 电源电缆 DC power cable | CW-259-2M | | 2 m |

操作手册 Operation manual, 快速指南 Quick reference, 安装手册 Installation manual, 安装材料 Installation material, 配件 Spare parts

选配 Option

Gyro-log 接口 Gyro-Log interface, 电源整流器 Power rectifier, AC 电缆 AC power cable, 水防护 RGB 电缆 Water protection RGB cable

连接示意图/ Connecting drawings

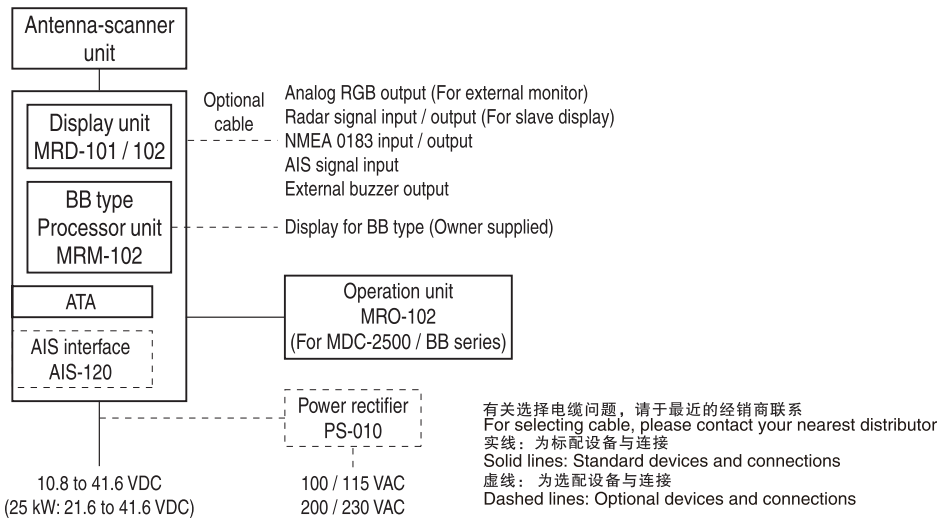

尺寸与重量/ Dimension and weight

Display unit:

MRD-101 (MDC-2200 series)

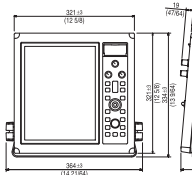

Weight: 8.2 kg (18 lb)

MRD-102 (MDC-2500 series)

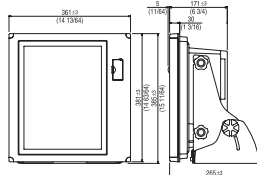

Weight: 12.5 kg (27.5 lb)

Antenna-scanner unit:

RB716A / RB717A / RB718A with RW701A-03 / 04 / 06

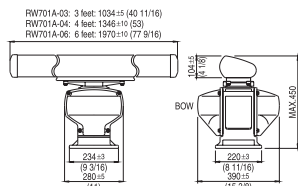

Weight:
RB716A
3 feet: 21 kg (46 lb)
4 feet: 22 kg (49 lb)
RB717A / 718A
4 feet: 23 kg (51 lb)
6 feet: 25 kg (56 lb)

Operation unit:

MRO-102 (MDC-2500 / BB series)

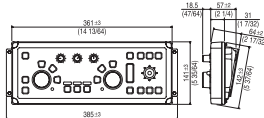

Weight: 2 kg (4.5 lb)

Processor unit:

MRM-102 (MDC-2500BB series)

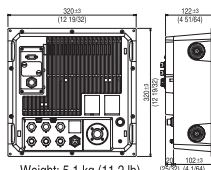

Weight: 5.1 kg (11.2 lb)

RB719A

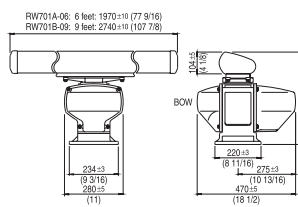

Weight:
RB719A
6 feet: 29 kg (64 lb)
9 feet: 33 kg (73 lb)

设计与规格改变恕不另行通知
Design and specifications are subject to change without notice.

Unit: mm (inch)